

PC357NT

Mini-flat Package, General Purpose Photocoupler

■ Features

1. Opaque type, mini-flat package
PC357NT (1-channel)
2. Subminiature type
(The volume is smaller than that of our conventional DIP type by as far as 30 %.)
3. Current transfer ratio
(CTR: MIN. 50% at $I_F = 5\text{mA}$, $V_{CE} = 5\text{V}$)
4. Isolation voltage between input and output
PC357NT ••• $V_{iso} : 3\,750V_{rms}$
5. Recognized by UL (No. E64380)

■ Applications

1. Hybrid substrates that require high density mounting
2. Programmable controllers

■ Package Specifications

Model	Package specifications
PC357NT	Taping reel diameter 178mm (750pcs.)

■ Absolute Maximum Ratings

($T_a = 25^\circ\text{C}$)

Parameter		Symbol	Rating	Unit
Input	Forward current	I_F	50	mA
	*1 Peak forward current	I_{FM}	1	A
	Reverse voltage	V_R	6	V
	Power dissipation	P	70	mW
Output	Collector-emitter voltage	V_{CEO}	35	V
	Emitter-collector voltage	V_{ECO}	6	V
	Collector current	I_C	50	mA
	Collector power dissipation	P_C	150	mW
Total power dissipation		P_{tot}	170	mW
*2 Isolation voltage		V_{iso}	3 750	V_{rms}
Operating temperature		T_{opr}	- 30 to + 100	$^\circ\text{C}$
Storage temperature		T_{stg}	- 40 to + 125	$^\circ\text{C}$
*3 Soldering temperature		T_{sol}	260	$^\circ\text{C}$

*1 Pulse width $\leq 100\mu\text{s}$, Duty ratio: 0.001

*2 40 to 60% RH, AC for 1 minute

*3 For 10 seconds

■ Outline Dimensions

(Unit : mm)

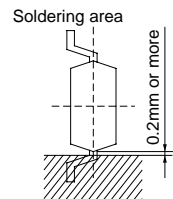
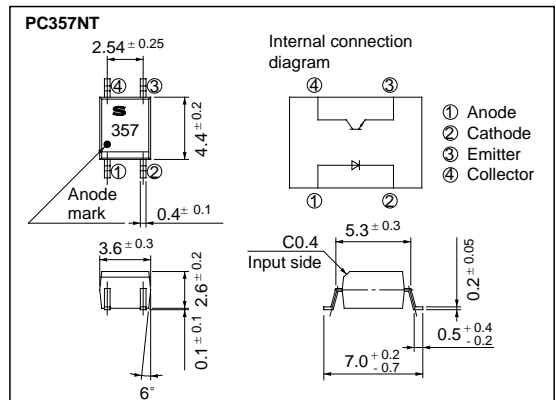

■ Electro-optical Characteristics

(Ta = 25°C)

Parameter		Symbol	Conditions	MIN.	TYP.	MAX.	Unit
Input	Forward voltage	V_F	$I_F = 20\text{mA}$	-	1.2	1.4	V
	Reverse current	I_R	$V_R = 4\text{V}$	-	-	10	μA
	Terminal capacitance	C_t	$V = 0, f = 1\text{kHz}$	-	30	250	pF
Output	Collector dark current	I_{CEO}	$V_{CE} = 20\text{V}, I_F = 0$	-	-	10^{-7}	A
	Collector-emitter breakdown voltage	BV_{CEO}	$I_C = 0.1\text{mA}, I_F = 0$	35	-	-	V
	Emitter-collector breakdown voltage	BV_{ECO}	$I_E = 10\mu\text{A}, I_F = 0$	6	-	-	V
Transfer-characteristics	*4 Current transfer ratio	CTR	$I_F = 5\text{mA}, V_{CE} = 5\text{V}$	50	-	600	%
	Collector-emitter saturation voltage	$V_{CE(sat)}$	$I_F = 20\text{mA}, I_C = 1\text{mA}$	-	-	0.2	V
	Isolation resistance	R_{ISO}	DC500V, 40 to 60% RH	5×10^{10}	10^{11}	-	Ω
	Floating capacitance	C_f	$V = 0, f = 1\text{MHz}$	-	0.6	1.0	pF
	Response time	Rise time	t_r	$V_{CE} = 2\text{V}, I_C = 2\text{mA}$	-	4	18
Fall time		t_f	$R_L = 100\Omega$	-	3	18	μs

*4 Classification table of current transfer ratio is shown below.

■ Current Transfer Ratio (CTR) Line-ups

Model No.	Rank mark	CTR (%)
PC357N1T	A	80 to 160
PC357N2T	B	130 to 260
PC357N3T	C	200 to 400
PC357N4T	D	300 to 600
PC357N5T	A or B	80 to 260
PC357N6T	B or C	130 to 400
PC357N7T	C or D	200 to 600
PC357N8T	A, B or C	80 to 400
PC357N9T	B, C or D	130 to 600
PC357N0T	A, B, C or D	80 to 600
PC357NT	A, B, C, D or No mark	50 to 600

Fig. 1 Forward Current vs. Ambient Temperature

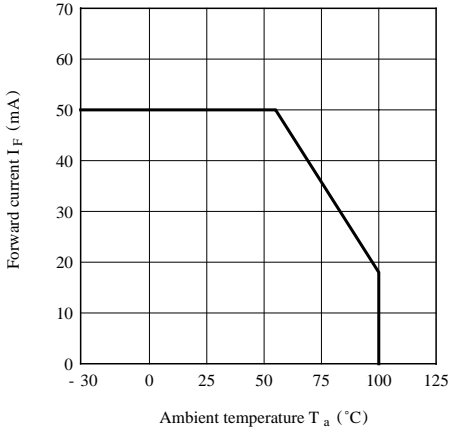

Fig. 2 Diode Power Dissipation vs. Ambient Temperature

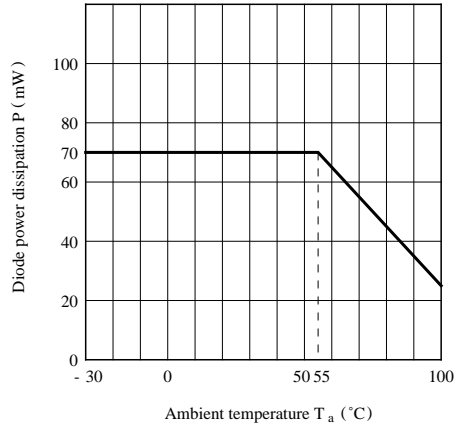

Fig. 3 Collector Power Dissipation vs. Ambient Temperature

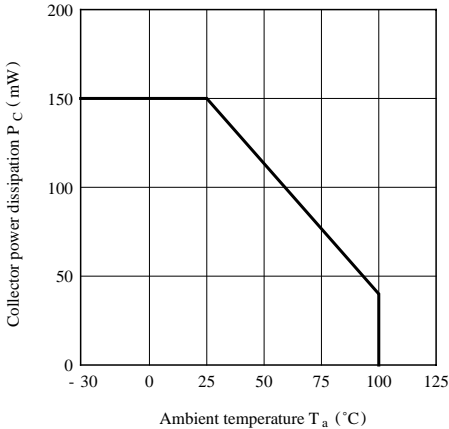

Fig. 4 Total Power Dissipation vs. Ambient Temperature

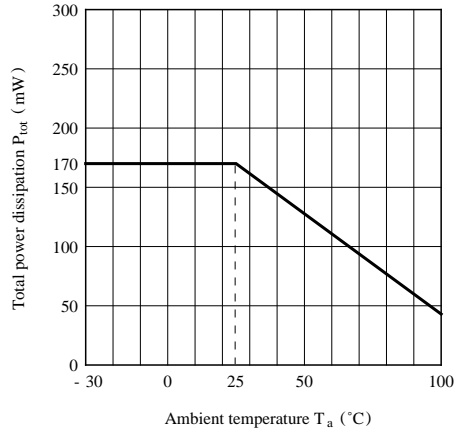

Fig. 5 Peak Forward Current vs. Duty Ratio

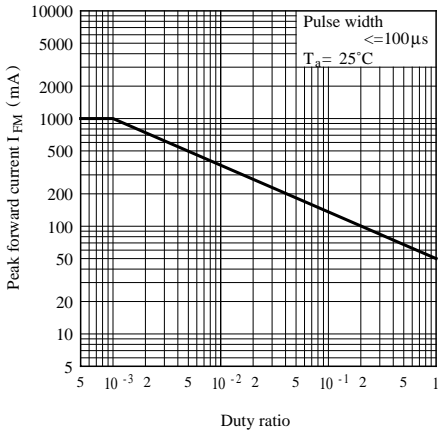

Fig. 6 Forward Current vs. Forward Voltage

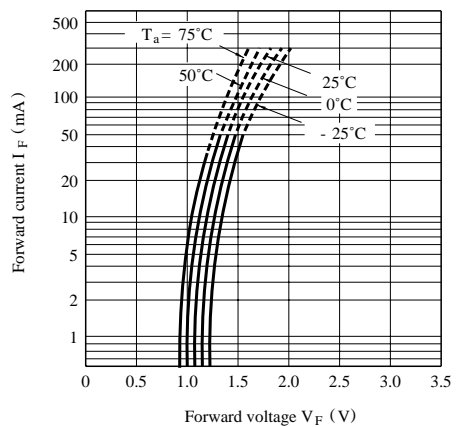

Fig. 7 Current Transfer Ratio vs. Forward Current

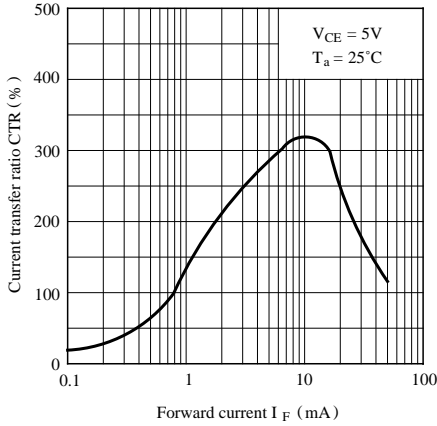

Fig. 8 Collector Current vs. Collector-emitter Voltage

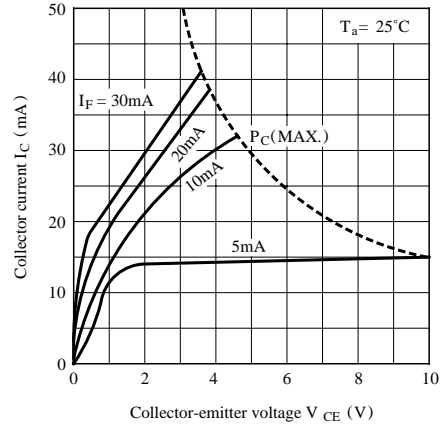

Fig. 9 Relative Current Transfer Ratio vs. Ambient Temperature

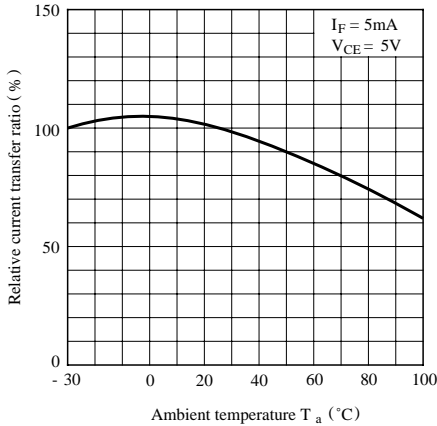

Fig.10 Collector-emitter Saturation Voltage vs. Ambient Temperature

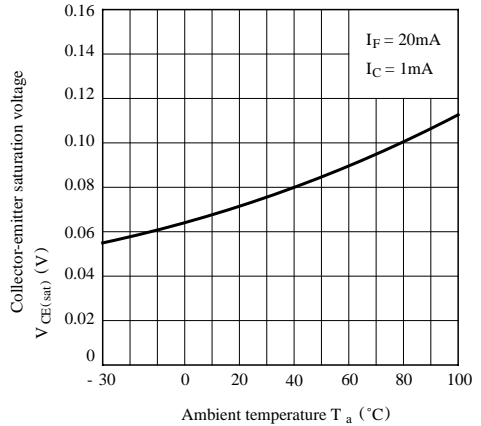

Fig.11 Collector Dark Current vs. Ambient Temperature

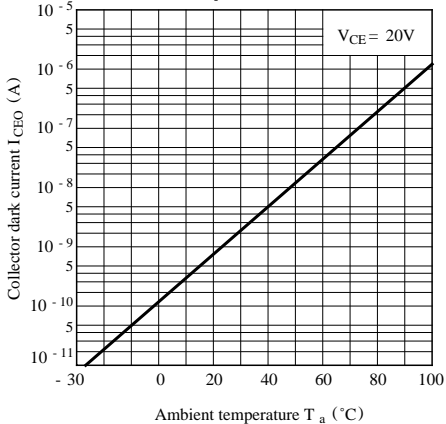
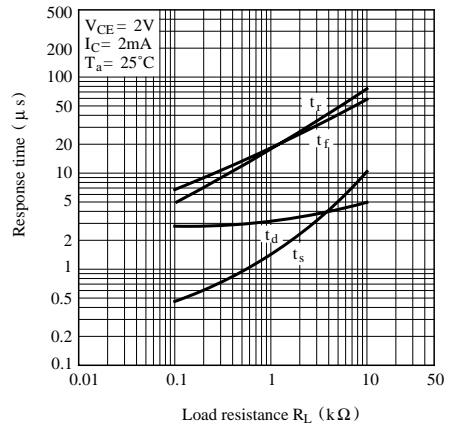

Fig.12 Response Time vs. Load Resistance



Test Circuit for Response Time

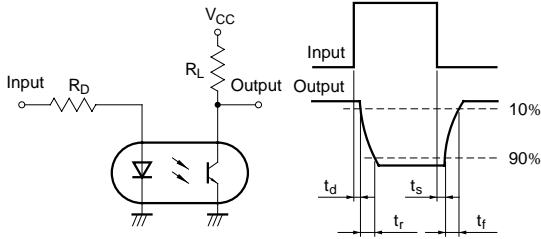
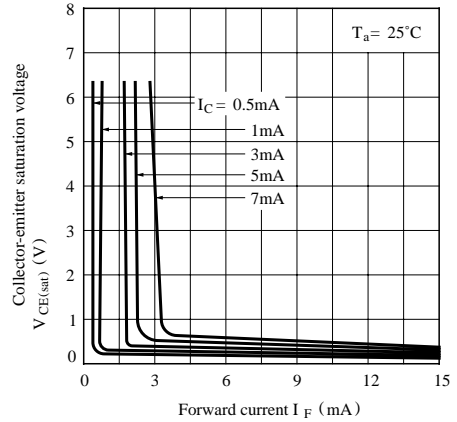
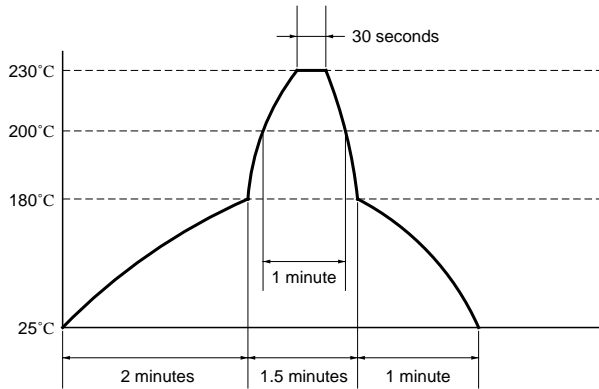

Fig.13 Collector-emitter Saturation Voltage vs. Forward Current



Temperature Profile of Soldering Reflow

(1) One time soldering reflow is recommended within the condition of temperature and time profile shown below.



(2) When using another soldering method such as infrared ray lamp, the temperature may rise partially in the mold of the device.

Keep the temperature on the package of the device within the condition of above (1).

(3) As for other general cautions, refer to the chapter "Precautions for Use"

NOTICE

- The circuit application examples in this publication are provided to explain representative applications of SHARP devices and are not intended to guarantee any circuit design or license any intellectual property rights. SHARP takes no responsibility for any problems related to any intellectual property right of a third party resulting from the use of SHARP's devices.
- Contact SHARP in order to obtain the latest device specification sheets before using any SHARP device. SHARP reserves the right to make changes in the specifications, characteristics, data, materials, structure, and other contents described herein at any time without notice in order to improve design or reliability. Manufacturing locations are also subject to change without notice.
- Observe the following points when using any devices in this publication. SHARP takes no responsibility for damage caused by improper use of the devices which does not meet the conditions and absolute maximum ratings to be used specified in the relevant specification sheet nor meet the following conditions:
 - (i) The devices in this publication are designed for use in general electronic equipment designs such as:
 - Personal computers
 - Office automation equipment
 - Telecommunication equipment [terminal]
 - Test and measurement equipment
 - Industrial control
 - Audio visual equipment
 - Consumer electronics
 - (ii) Measures such as fail-safe function and redundant design should be taken to ensure reliability and safety when SHARP devices are used for or in connection with equipment that requires higher reliability such as:
 - Transportation control and safety equipment (i.e., aircraft, trains, automobiles, etc.)
 - Traffic signals
 - Gas leakage sensor breakers
 - Alarm equipment
 - Various safety devices, etc.
 - (iii) SHARP devices shall not be used for or in connection with equipment that requires an extremely high level of reliability and safety such as:
 - Space applications
 - Telecommunication equipment [trunk lines]
 - Nuclear power control equipment
 - Medical and other life support equipment (e.g., scuba).
- Contact a SHARP representative in advance when intending to use SHARP devices for any "specific" applications other than those recommended by SHARP or when it is unclear which category mentioned above controls the intended use.
- If the SHARP devices listed in this publication fall within the scope of strategic products described in the Foreign Exchange and Foreign Trade Control Law of Japan, it is necessary to obtain approval to export such SHARP devices.
- This publication is the proprietary product of SHARP and is copyrighted, with all rights reserved. Under the copyright laws, no part of this publication may be reproduced or transmitted in any form or by any means, electronic or mechanical, for any purpose, in whole or in part, without the express written permission of SHARP. Express written permission is also required before any use of this publication may be made by a third party.
- Contact and consult with a SHARP representative if there are any questions about the contents of this publication.